



Professional

AUDIO/VISUAL MOUNTING SOLUTIONS

peerless-AV

peerless-AV



With the creation of the industry's first TV Mount in 1964, Peerless leads the way in today's digital environments. Our drive to innovate continues with everything we do. From the very first flat panel mount, to the only precision gear projector mount, to the world's undisputed thinnest flat panel mounts, Peerless delivers form, function and innovation in every product we produce.

In addition to being at the forefront of innovation, Peerless drove the establishment of safety standards for AV mounts over a decade ago with Underwriters Laboratories (UL). Peerless mounts are designed and manufactured in our state-of-the-art facility, giving Peerless full control over production and quality.

Peerless' pledge

Peerless strives to improve the quality of life for people and the environment around the world. We work together on a daily basis with our suppliers to help create a more sustainable approach to manufacturing professional-quality, professional-grade mounting solutions while minimising our environmental footprint.



Use highest recyclable content materials while maintaining our industry-leading strength and quality

RoHS
2002/95/EC

Directive 2002/95/EC compliant to maintain the highest health and safety standards of our customers and environment

Peerless' dedication

From professional installations into homes, schools and virtually anywhere, to the retail shelf, Peerless offers innovative products for every possible application. Working closely with TV manufacturers, professional installers and integrators, we create mounting solutions that are simple-to-install, offer incredible versatility and are ready for the latest technology and trends. We are dedicated to providing simply the best AV mounting solutions.

Peerless' commitment

For decades, we have led the industry with the highest levels of safety and quality. Today, millions of Peerless mounts are in use around the world, trusted by professional installers and relied on by consumers.



Setting the standard for safety around the globe



Upholding the highest compatibility standards

**CERTIFIED
ISO 9001**

Certified quality in every product

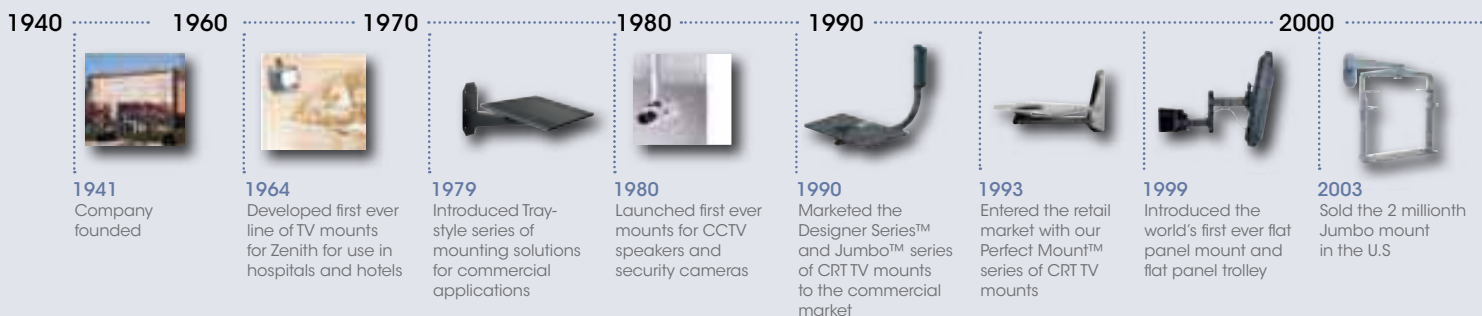

If you can imagine it, we can create it with Peerless Custom Mounting Solutions



Peerless CMS places the resources of the industry leader in custom mounting solutions at your disposal. Whether your requirement it is a simple modification to a standard Peerless product or a large scale, fully bespoke installation, Peerless CMS has the experience, know-how and facilities to make your solution a reality.

Special customer requests are the very reason why Peerless CMS exists. Through our customer focused D3 process - Design, Develop and Deploy, we work with you from creating the initial concept through to the installation of your solution.

We offer highly trained teams of people who not only understand AV mounts, but also are experienced at serving your market. They are backed by over 40 years of experience.

Peerless is driven by the challenge of unique customer requirements. We have a long history of creating innovative solutions in every Professional Market - from hotels, restaurants, retail stores, hospitals, stadiums, pubs and clubs, schools and universities, we are ready to help you.

When you are thinking about custom mounting solutions, insist on Peerless.

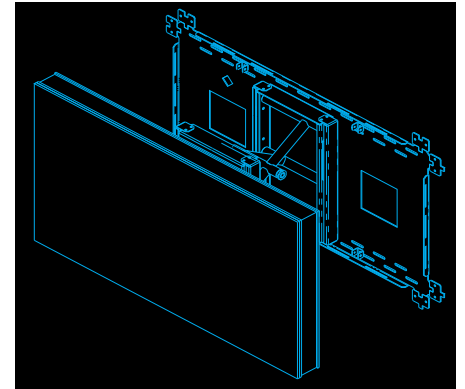

2006
Introduced the industry's first high-gloss series of mounts



2007
Introduced the industry's first ever precision gear projector mount



2007
Launched Paramount™ by Peerless, a comprehensive, value-added range of mounting solutions



2008
Introduced the world's thinnest flat panel mount. At only 8.4 mm (0.33") from the wall, the Slimline® mounts were designed to work with ultra-thin flat panels

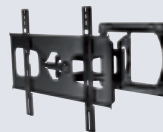

2009
Articulating and tilting wall mounts expand the Slimline range



2010
Introduced new range of Peerless AV Furniture



2010
Introduced new range of Peerless AV Cables

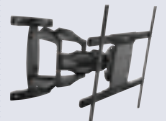

2010
Launched re-designed SmartMount premium pivot and articulating arm wall mounts

Digital signage



Excellence in Digital Signage starts with outstanding content and correct screen placement.

Peerless brand mounting solutions have been deployed in thousands of locations all over the globe. Integrators, installers and network administrators have relied upon Peerless products for safety, durability and ease of installation for years.

From standard products to custom designed speciality mounts, Peerless leads the way in Digital Signage with a full range of high quality solutions to suit any requirement.

Trust Peerless to help you create outstanding Digital Signage mounting solutions.

PRODUCT SPOTLIGHT

MOD-FPSKIT150

1.5m ceiling kit for single flat panel screen

Simple installation and reliable screen placement, perfect for ceiling-mounted digital signage (dual back-to-back or double-stack screen options available)

- Cathedral ceiling plate can be angled up to $\pm 60^\circ$ for use with vaulted or sloping ceilings
- 50mm diameter column supplied as 1.5m length and cuttable to required size (3m length optional)
- Internal cable management allowing cables to be routed into main pole and out of sight
- Universal screen adaptor plate suitable for screens up to 60"
- Portrait or landscape screen installation for added versatility in digital signage applications
- Maximum load capacity 120kg (264lbs)



See page 22 for full specifications

Education & training



As the leader in mounting solutions for the US Education market, Peerless has supplied more TV, monitor and projector mounts for educational and training facilities than any other company.

This wealth of knowledge, with so many products installed throughout the US educational system, means that Peerless has extensive experience and subsequently the conversion from CRT TVs to Flat Panel Displays is made easier when upgrading and installing new Peerless mounts.

Innovative new products including short throw and ultra short throw projector arms, along with interactive white board mounts have been developed to complement the changing technology and requirements in the education market.

PRODUCT SPOTLIGHT

PRG-UNV

PRG precision gear projector mount

Fast installation and even faster image alignment, the award-winning PRG mount allows quick and precise installations, especially for multiple projector applications

- Patent pending precision gear provides ImageLock™ alignment to accurately hold image position, virtually eliminating any sag or drift
- Two adjustment controls for tilt and roll image alignment – engage using a Phillips screwdriver or adjust by hand
- Spider® universal adaptor plate extends up to 448mm to fit most projector models
- Can be flush mounted or used in conjunction with extension poles and plates
- Maximum load capacity 22kg (50lbs)



See page 10 for full specifications

Peerless has a wide range of 'market specific' mounting solutions. Shown above and throughout this brochure are the range highlights. Contact Peerless-AV UK to request a dedicated catalogue on any specific market sector or visit www.peerless-av.co.uk for more information.

Hospitality solutions



Winning hospitality takes vision and it takes a special company to help you make those visions a reality.

Peerless is the leader in providing AV mounting solutions that meet and exceed the exacting standards for security, durability and aesthetics the hospitality industry demands.

With a comprehensive line of mounting solutions designed for hospitality and a dedicated in-house custom product development team - we are ready to help you complete your winning vision.



HP432-002

Desktop swivel mount for LCD screens

Desktop mounts not only provide flexible viewing options, easy and clean installation, but also is the perfect option to protect against sound transmission from room to room

- Ideally suited for LCD screens 22-40" in size
- 30° of swivel to each side (60° in total)
- Screen height adjustment from 399mm to 553mm (15.7"-21.8"), adjustable in 38mm (1.5") increments
- Bolt down mount for secure attachment
- Supplied with security screws
- Accommodates VESA® 100, 200x100 and 200x200 mounting patterns
- Maximum load capacity 36kg (80lbs)



See page 27 for full specifications

Corporate & office



Peerless' comprehensive portfolio of mounting solutions and in-house design enables us to offer a solution for every type of display to meet your requirements in a Corporate or Office environment.

From Ultra-Slim flat panel mounts, ideal to complement the latest ultra thin LED screens to create an eye-catching focal point for a reception area or foyer, to mobile AV trolleys & stands, perfect for supporting large screens and presentation equipment that can be moved between meeting rooms or public areas, Peerless has a full range of screen mounting products to meet any situation.

This is complemented by a comprehensive array of desktop arms for single or multiple computer monitors and a complete range of projector mounts and accessories.



SR560M

Universal trolley for LCD and Plasma screens

The SR560 trolley is ideal for a corporate or office environment, able to adapt via its many accessory options to provide a mobile solution for video conferencing, presentations and even entertainment.

- Ideally suited for 32-60" LCD and Plasma screens
- Incremental tilt angle (-2, 0, +5°) together with continuous height adjustment on 1.66m (65") column for optimum viewing position
- 100mm swivel castors allow for easy movement and trolley positioning (two locking castors)
- Adjustable tempered glass (SR560G) or metal shelf (SR560M) to hold AV equipment and accessories
- Internal cable management
- Total maximum load (screen + shelves) 114kg (250lbs)



See page 28 for full specifications

Peerless has a wide range of 'market specific' mounting solutions. Shown above and throughout this brochure are the range highlights. Contact Peerless-AV UK to request a dedicated catalogue on any specific market sector or visit www.peerless-av.co.uk for more information.

Mount Finder™

It's the easy way to match the right Peerless mount to a screen. With the ability to search through thousands of flat panel or projector models, users can quickly locate the ideal Peerless mount for their flat panel screen or projector. The most advanced mount compatibility system available, from the company that pioneered the Mount Finder™ technology.

Option 1



Enter the model number of your LCD TV, Plasma TV or projector

OR

Option 2



Select the brand of your LCD/Plasma TV or projector



Next - select the model number of your TV or projector

Result



A selection of mounts for your model of flat panel TV or projector will then be displayed. You can then Click on each model for more details

Visit - www.peerless-av.co.uk

PROJECTOR MOUNTS

Modular Series Projector Kit	08
Modular Series Quick Reference Guide	09
Projector Mounts	10
Security Projector Mounts	10
Projector Enclosure	10
Paramount Projector Mount Kits	11

SHORT THROW PROJECTOR MOUNTS

Short & Ultra-short Throw Projector Mounts & Kits	12
Custom Solutions Ultra short throw projector mount Interactive white board solutions	13

FLAT PANEL WALL MOUNTS

Slimline : low-profile, close-to-wall Complement LED screens	14-15
SmartMount : versatile, feature packed Screen sizes 10" to 102"	16-17
Paramount : functional, uncomplicated Quick & easy to install	18-19
Speciality Wall Mounts	20-21
ONE Mount	
Portrait & Landscape mounts	
Pull-out swivel mount	
Corner mounts	
In-Wall mounts & boxes	
Menu board mount	
Tilt wall mount with content storage	
Video Wall mount	

FLAT PANEL CEILING MOUNTS

Modular Series Single Screen Kit	22
Modular Series Quick Reference Guide	23
Paramount Ceiling Mount Kits	24
Speciality Ceiling Mounts Multi Display solutions Custom digital signage 85" Panasonic screen mount	25

DESKTOP SCREEN MOUNTS

Articulating Desktop Mount	26
Multiple Screen Desktop Mounts	26
Speciality Hospitality Mounts Desktop Swivel mounts Security kits	27

TROLLEYS AND STANDS

SR Trolleys, SS Stands and accessories	28
FPZ stands	29
Pedestal Mounts	29

ACCESSORIES

Cable Management	30
AV Equipment Shelves	30
Speaker & Camera Mounts	30

PEERLESS PRO CEILING MOUNTS

Projector & Flat Panel Screen Kits	31
Ceiling Plates	32
Extension Poles & Adaptors	33
Screen Adaptor Plates & Projector Mounts	34

Modular Series projector mount kit

NEW

Peerless constantly strives to improve the versatility and ease of use of our products and having listened to the feedback from installers and integrators it is apparent that the market requires a product range that can fulfil multiple requirements from a limited number of SKUs. Thus the Modular Series has been introduced as a universal ceiling mount solution with just a dozen component options making up the full projector mount range.

With the ability to select the required ceiling plate and column length, along with a choice of projector mounts and adaptor plates this is an incredibly versatile system. If that wasn't simple enough Peerless has created a one-box kit (PRSKIT150) that will be perfect for many professional installations. Manufactured from the highest quality materials and tested in excess of industry standards the Modular Series provides the assurance of durability and safety.

MOD-PRSKIT150 1.5m projector ceiling mount kit

Kit includes:

- 1 x MOD-CPC: Cathedral ceiling plate
- 1 x MOD-P150: 1.5m chrome pole
- 1 x MOD-APRS: Projector adaptor
- 1 x PRS-UNV: PRS-UNV projector mount



1 Choose the ceiling plate

Heavy Duty Ceiling Plate MOD-CPF



Mounts to concrete and wood joist ceilings
Max Weight: 170kg (374lbs)

Cathedral Ceiling Plate MOD-CPC



Mounts to concrete and wood joist ceilings
Tilt: +/- 60° Max Weight: 120kg (264lbs)

I-Beam Ceiling Plate MOD-CPI



Fully adjustable for I-beams 85mm to 250mm wide
Tilt: +/- 60° Max Weight: 120kg (264lbs)

U-Bolt Accessory Kit MOD-AUB



Clamps around 40mm to 85mm (1.5-3.3") diameter pipes, trusses etc.
Adapts to MOD-CPC & MOD-CPF
Max Weight: 120kg (264lbs)

2 Select the pole length

Extension Poles

MOD-P150: 1.5m (59") length (Chrome)

MOD-P300: 3.0m (118") length (Chrome)



Cuttable to desired length Diameter: 50.8mm (2")

3 Projector adaptor plate

Projector Mount Adaptor MOD-APRG



PRG projector mount adaptor
Max Weight: 30kg (66lbs)

Projector Mount Adaptor MOD-APRS



PRS & PSMU projector mount adaptor
Max Weight: 30kg (66lbs)

4 Required projector mount

PRG Projector Mount

PRG-UNV/BK (Black) Also available in Silver (/S) and White (/W)



Tilt: ±20° Pan: 360° Roll: ±10° Max Weight: 23kg (50lbs)
Mounting Pattern: Universal up to 448mm

PRS Projector Mount

PRS-UNV/BK (Black) Also available in Silver (/S) and White (/W)



Tilt: +20°/-5° Pan: 360° Roll: ±10° Max Weight: 11kg (25lbs)
Mounting Pattern: Universal up to 448mm

Projector Enclosure

PE1120 (Black) Also available in White (/W) as shown



Secures and protects virtually any projector and mount up to 508x508x280mm (20"x20"x11") (WxDxH)

Security Mount

PSMU-PRS (Black) Also available in White (/W) as shown



Tilt: +20°/-5° Swivel: 360° Roll: ±10° Max Weight: 11kg (25lbs)
Mounting Pattern: Universal tray pattern up to 330x280mm

PRG Precision Gear projector mount

- Patent pending precision gear provides ImageLock™ alignment to accurately hold image position, virtually eliminating any sag or drift
- Two adjustment controls for tilt and roll image alignment – engage using a Phillips screwdriver or adjust by hand
- Spider® universal adaptor plate extends up to 448mm to fit most projector models
- Can be flush mounted or used in conjunction with extension poles and plates
- Quick release mechanism to easily service projector
- Horizontal wrench access slots make flush mounting installations quick and easy
- Pre-installed security screws provide optional tilt and roll lock to prevent tampering with adjustment controls
- Cable management allows cables to be routed through projector mount and out of sight
- Available in black, silver (-S) and white (-W) finishes
- Screen specific models available. Please see contact the Peerless-AV sales team on +44 (0)1923 200 100



Compatible with both Peerless Modular ceiling kits (see previous page) and Peerless Pro ceiling kits (see pages 31-34)

Technical Specifications

Part No.	Tilt/Pan/Roll	Colour	Max. weight	Mounting pattern
PRG-UNV	±20°, 360°, ±10°	Black, Silver or White	23kg (50lbs)	Universal (up to 448mm)

PRS projector mount

- Low profile design allows projector to be close to ceiling
- Spider® universal adaptor plate extends up to 448mm to fit most projector models
- Can be flush mounted or used in conjunction with extension poles and plates
- Quick release mechanism to easily service projector
- Pre-installed security screws provide optional tilt and roll lock to prevent tampering with adjustment controls
- Cable management via access opening allows cables to be routed through projector mount and out of sight
- Available in black, silver (-S) and white (-W) finishes



Compatible with both Peerless Modular ceiling kits (see previous page) and Peerless Pro ceiling kits (see pages 31-34)

Technical Specifications

Part No.	Tilt/Pan/Roll	Colour	Max. weight	Mounting pattern
PRS-UNV	+20°/-5°, 360°, ±10°	Black, Silver or White	11kg (25lbs)	Universal (up to 448mm)

Projector security mounts

- Key-lock security for theft deterrence
- Universal tray pattern accommodates most projectors
- Two piece tray design with barrel key lock prevents access to security fasteners
- Easy access hinge designed for quick projector removal, enabling lamp and filter maintenance
- Top access hole for cable management
- Security fasteners included
- Available in black and white (-W) finishes



Compatible with both Peerless Modular ceiling kits (see previous page) and Peerless Pro ceiling kits (see pages 31-34)

Technical Specifications

Part No.	Tilt/Pan/Roll	Colour	Max. weight	Mounting pattern
PSMU-PRS	+20°/-5°, 360°, ±10°	Black or White	11kg (25lbs)	Universal tray pattern

Projector enclosure

- For use with projector mounts
- Secures and protects virtually any projector and mount up to 508 x 508 x 28mm (w x d x h)
- Retro-fit capable without altering existing installation
- Simple three-step installation
- Adjustment bars accommodate projector lens placement
- For use with Peerless projector mounts, ceiling plates and extension poles
- 'Hook-n-Hang' feature allows hands-free operation during projector installation or maintenance on projector close to ceiling
- Projector mount purchased separately
- Available in black or white (-W) finish



Compatible with both Peerless Modular ceiling kits (see previous page) and Peerless Pro ceiling kits (see pages 31-34)

Requires **PRG or PRS** projector mounts - sold separately

Technical Specifications

Part No.	Colour	Universal for projectors
PE1120	Black or White	508x508x28mm (WxDxH)

Flush ceiling projector mount

PARAMOUNT™
BY PEERLESS



- Low profile design for flush mount installations only
- Provides full range of image adjustment
- Spider® universal adaptor plate extends up to 448mm to fit most projector models
- Available in black, silver (-S) and white (-W) finishes

Technical Specifications

Part No.	Tilt	Pan	Roll	Colour	Max. weight	Mounting pattern
PPF	+30°/-5°	±20°	±20°	Black, Silver or White	23kg (50lbs)	Universal (up to 448mm)

Ceiling/wall projector mount with adjustable extension



- Continuous channel design for uninterrupted drop length or wall extension adjustments
- Safety catch designed into extension to ensure user and equipment safety
- Internal cable management within channels for clean and tidy appearance
- Mounts to ceiling or wall (PPA and PPB models)
- Mounts to ceiling (PPC models)
- Spider® universal adaptor plate extends up to 448mm to fit most projector models
- Works with standard 102mm (4") loops for use with round, square, rectangular or I-beam truss up to 76 x 89mm / 3 x 3.5" (w x h)
- Available in black, silver (-S) and white (-W) finishes

Technical Specifications

Part No.	Ceiling/wall extension	Tilt/Pan/Roll	Max. weight	Colour	Mounting pattern
PPA	324-452mm/253-357mm	+30°/-5°, ±360°, ±20°	23kg (50lbs)	Black, Silver or White	Universal (up to 448mm)
PPB	425-652mm/354-557mm	+30°/-5°, ±360°, ±20°	23kg (50lbs)	Black, Silver or White	Universal (up to 448mm)
PPC	589-962mm (ceiling only)	+30°/-5°, ±360°, ±20°	23kg (50lbs)	Black, Silver or White	Universal (up to 448mm)

Short & ultra short throw projector arms and kit



- **PSTA-028 & PSTK-028** - Sliding carriage design allows projector mount to glide into place at any location on the short throw arm from 0 - 711mm (0 - 28")
- **PSTA-2955 & PSTK-2955** - Telescoping arm extends from 1026 - 1669mm (29 - 55")
- Access slots allow for all internal cable management
- **PSTK-2955 & PSTK-028** kit versions comes with double stud wall plate and allows 152mm (6") of lateral adjustment for precise alignment of the ultra-short throw projector
- Pre-installed security screws lock down short throw arm and prevent tampering
- Supplied complete with Peerless' Universal Precision Gear Projector Mount (PRG-UNV), featuring patent-pending precision gears that provide exact projector image alignment
- Available in black or white (-W) finishes

Technical Specifications

Part No.	Tilt/Pan/Roll	Colour	Max. weight	Mounting pattern
PSTA-028	±20°/±15°/±10°	Black	23kg (50lbs)	Universal (up to 448mm)
PSTK-028	±20°/±15°/±10°	Black	23kg (50lbs)	Universal (up to 448mm)
PSTA-2955	±20°/±15°/±10°	Black	16kg (35lbs)	Universal (up to 448mm)
PSTK-2955	±20°/±15°/±10°	Black	16kg (35lbs)	Universal (up to 448mm)

Short and ultra-short throw projector arms

NEW



- Adjustable extension suitable for use with interactive white boards
- Quick-release mechanism allows fast projector install/removal for maintenance
- Security screws included to safeguard projector
- Universal adaptor plate for projectors up to 11kg and mounting pattern to 448mm
- Internal cable management with easy-access cover
- Key slots built into wall plate enable one-person installation
- Low-profile wall plate and high arm position allow installation into room with low ceilings
- Sturdy construction tested to hold over 75Kg

Technical Specifications

Part No.	Tilt/Pan/Roll	Colour	Max. projector weight	Arm Length	Extension
PSTK-PRSU/WH	+20°, -5° / ±10° / ±15°	White	11kg (25lbs)	1404mm	1040mm to 1310mm
PUSTK-PRSU/WH	+20°, -5° / ±10° / ±15°	White	11kg (25lbs)	719mm	320mm to 620mm

Short or ultra short throw...

peerless® has a custom mounting solution for you

Shown here is a selection of products for the Hitachi CP-A100 ultra short throw projector.
For solutions to other projectors and interactive white boards, contact the Peerless-AV sales team.

CPA100WALLARM

- Mounts to any flat surface
- Includes horizontal, vertical and front to back adjustments
- Features PRG projector mount



A100IWBMOUNT

- Spring assisted vertical adjustment allows projector & screen to be raised/lowered together
- Includes horizontal, vertical and front to back adjustments
- Features PRG projector mount



A100IWBCART



- Works in conjunction with A100IWBMOUNT
- Integrated cable management and locking wheels



Special customer requests are the very reason why Peerless CMS exists. Through our customer focused D3 process - Design, Develop and Deploy, we work with you from creating the initial concept through to the installation of your solution.

For more information contact the Peerless-AV sales team on +44 (0) 1923 200 100

Ultra Slim™

NEW



The Ultra Slim range has been specifically designed and developed to complement the very latest ultra thin flat panel screens (measuring 51mm (2") max depth). Becoming slimmer all the time, these ultra flat screens require a wall mount that positions the screen as close to the wall as possible.

This is the thinnest flat-to-wall mounting solution at only 0.84cm – yes, that's only 8.4mm! – making it almost invisible once installed. The range also includes a tilt and fully articulating option that retain the same low profile design yet offer exceptional features and functionality.

The Ultra Slim mounts offer simple fitting, a flexible screen mounting design, secure support and innovative features for maximum versatility - so make a stunning statement with the most discrete wall mount ever developed for your brand new screen.

Ultra Slim™ Flat to Wall Mounts

- Industrial strength Velcro® latching system**
 secures screen adaptors to wall plate in a single step
- Horizontal screen adjustment**
 of up to 203mm (8")
- Universal brackets**
 easily hook onto wall plate for a quick and simple installation
- Ultra-thin design**
 holds screen only 8.4mm (0.33") from the wall for a near-invisible application
- Universal mount**
 compatible with ultra-thin screens with mounting patterns up to 800x 400mm (SUF660P)

Ultra Slim™ Tilting Wall Mounts

- Screen adaptors**
 simply hook on to wall plate for quick and easy installation
- Holds screen**
 17mm (0.68") from the wall
- Full Motion Tilt**
 allows for +17.5°/-5°
- Horizontal adjustment**
 up to 203mm (8")
- Screen extension**
 149mm (5.88") from the wall allowing for hands-free installation and access to the back of the screen

Ultra Slim™ Articulating Wall Mounts

Ultra Slim™



■ **Arm retracts**
to 28mm (1.1") and extends up to 734mm (28.9") from wall (SUA750PU)

■ **Side-to-side swivel**
up to ±90°

■ **±5° of roll**
to level screen horizontally

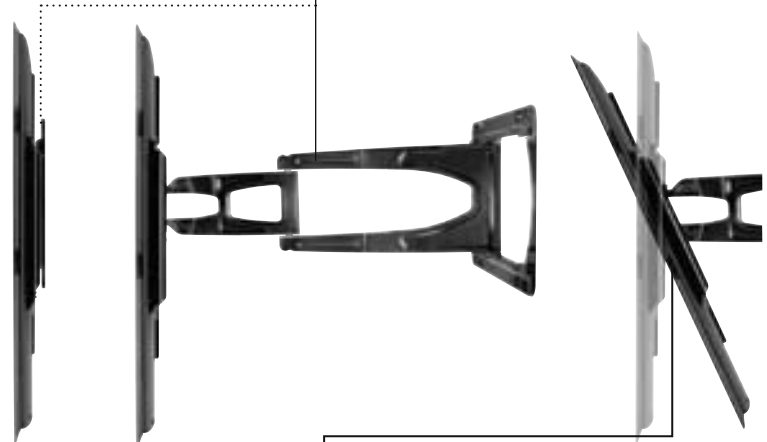

■ **One touch tilt**
allows adjustment of +15/-5° without the use of tools

	FLAT	TILT	ARTICULATING
MED/LARGE Screen sizes 32-46" Ultra-thin screens	SUF640P 	SUT645* 	SUA745PU* 
LARGE Screen sizes 37-55" Ultra-thin screens	SUF660P  <i>Suitable for screens up to 65"</i>	SUT660P*  <i>Suitable for screens up to 60"</i>	SUA750PU* 

*For screens less than 51mm in depth

Part No.	Screen sizes	Max. weight	Tilt	Pan	Roll	Distance from wall Closed - Extended	Mounting pattern
SUF640P	32-46"	68kg (150lbs)	n/a	n/a	n/a	8.4mm	Universal up to VESA 450x400mm
SUT645P	32-46"	45kg (100lbs)	+17.5/-5°	n/a	n/a	17mm - 149mm	Universal up to VESA 450x400mm
SUA745PU	32-46"	27kg (60lbs)	+15/-5°	±90°	±5°	28mm - 604mm	Universal up to VESA 450x400mm
SUF660P	37-65"	68kg (150lbs)	n/a	n/a	n/a	8.4mm	Universal up to VESA 800x400mm
SUT660P	37-60"	45kg (100lbs)	+17.5/-5°	n/a	n/a	17mm - 149mm	Universal up to VESA 800x400mm
SUA750PU	37-55"	45kg (100lbs)	+15/-5°	±90°	±5°	28mm - 734mm	Universal up to VESA 800x400mm



Simply the most versatile and easy to install mounts, yet packed with clever features, SmartMount represents a complete range of LCD and Plasma screen mounts designed to enhance any professional AV installation.

Be it a pub or club, guestroom, boardroom or classroom, all SmartMount products incorporate intelligent design to add value to a professional AV installation. Many models allow the screen to be displayed in portrait or landscape orientations, ideal for digital signage applications.

SmartMount models are available in a durable black finish to complement today's AV equipment. For the ultimate AV experience – choose SmartMount!

- **Minimalistic wall plate** footprint for increased wall access and aesthetics
- **Dual arm construction** for added strength and smooth motion on larger screens
- **One-touch tilt** allows adjustment of +15°/-5° without the use of tools
- **Screen rotation** from portrait to landscape without removing the screen
- **±5° roll adjustment** for leveling screen on wall
- **Horizontal adjustment** up to 114mm (4.5") for perfect screen placement
- **±12.5mm (0.5") vertical adjustment** for fine tuning of screen position
- **Arms extend** up to 699mm (27.53") from wall
- **Integrated cable management** provides ample clearance for cables for a professional and discrete installation

Dimensions & features relate to SA771PU model as shown

Recommended Accessories

ACC918



Security fasteners for mounts with VESA® 75, 100, and 200x100 mounting patterns

ACC919















Security fasteners for mounts with up to VESA® 400x300 mounting patterns

ACC925

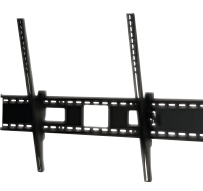

Security fasteners for all scalable wall mounts

	FLAT	TILT	PIVOT	ARTICULATING
SMALL Screen sizes 10-24" LCD	SF630P 	ST630P 	SP730P 	SA730P 
MEDIUM Screen sizes 22-40" LCD	SF632P 	ST632P 	SP740P 	SA740P 
MEDIUM/LARGE Screen sizes 26-46" LCD	SF640P  <i>(supports 23-46")</i>	ST640P  <i>(supports 23-46")</i>	SP746PU 	SA746PU 
LARGE Screen sizes 32-56" LCD/Plasma	SF650P 	ST650P 	SA752PU  <i>(supports 32-52")</i>	
X-LARGE Screen sizes 37-63" LCD/Plasma	SF660P 	ST660P 	SA761PU  <i>(supports 37-60")</i>	
XX-LARGE Screen sizes 42-71" LCD/Plasma	SF670P 	ST670P 	SA771PU  <i>(supports 37-71")</i>	
XXX-LARGE Screen sizes 61-102" LCD/Plasma	SF680P 	ST680P 		

Part No.	Screen sizes	Max. weight	Tilt	Pan	Roll	Arm extension	Mounting pattern
SF630P	10-24"	36kg (80lbs)	n/a	n/a	n/a	n/a	VESA 75 & 100
ST630P	10-24"	36kg (80lbs)	+15/-5°	n/a	n/a	n/a	VESA 75 & 100
SP730P	10-24"	11kg (25lbs)	±35°	±90°	±7°	237mm	VESA 75 & 100
SA730P	10-24"	11kg (25lbs)	±35°	±90°	±7°	408mm	VESA 75 & 100
SF632P	22-40"	52kg (115lbs)	n/a	n/a	n/a	n/a	VESA 75, 100, 200x100, 200x200
ST632P	22-40"	52kg (115lbs)	+15/-5°	n/a	n/a	n/a	VESA 75, 100, 200x100, 200x200
SP740P	22-40"	36kg (80lbs)	+15/-5°	±90°	±5°	300mm	VESA 75, 100, 200x100, 200x200
SA740P	22-40"	36kg (80lbs)	+15/-5°	±90°	±5°	513mm	VESA 75, 100, 200x100, 200x200
SF640P	23-46"	68kg (150lbs)	n/a	n/a	n/a	n/a	Universal up to 450x329mm
ST640P	23-46"	68kg (150lbs)	+15/-5°	n/a	n/a	n/a	Universal up to 458x329mm
SP746PU	26-46"	36kg (80lbs)	+15/-5°	±90°	±5°	319mm	Universal up to 432x408mm
SA746PU	26-46"	36kg (80lbs)	+15/-5°	±90°	±5°	531mm	Universal up to 432x408mm
SF650P	32-56"	80kg (175lbs)	n/a	n/a	n/a	n/a	Universal up to 742x433mm
ST650P	32-56"	80kg (175lbs)	+15/-5°	n/a	n/a	n/a	Universal up to 749x449mm
SA752PU	32-52"	41kg (90lbs)	+15/-5°	±90°	±5°	697mm	Universal up to 686x439mm
SF660P	37-63"	91kg (200lbs)	n/a	n/a	n/a	n/a	Universal up to 825x433mm
ST660P	37-63"	91kg (200lbs)	+15/-5°	n/a	n/a	n/a	Universal up to 831x449mm
SA761PU	37-60"	59kg (130lbs)	+15/-5°	±90°	±5°	700mm	Universal up to 686x439mm
SF670P	42-71"	113kg (250lbs)	n/a	n/a	n/a	n/a	Universal up to 908x503mm
ST670P	42-71"	113kg (250lbs)	+15/-5°	n/a	n/a	n/a	Universal up to 915x503mm
SA771PU	37-71"	91kg (200lbs)	+15/-5°	±90°	±5°	700mm	Universal up to 826x661mm
SF680	61-102"	159kg (350lbs)	n/a	n/a	n/a	n/a	Universal up to 1111x745mm
ST680	61-102"	159kg (350lbs)	+15/-5°	n/a	n/a	n/a	Universal up to 1119x745mm



With Paramount by Peerless, it couldn't be easier to choose the right mount for your screen... and the great news is that it's even easier to install!

Designed for ease of use and fast intuitive fitting by a professional installer, all Paramount products are finished in a stylish high gloss black to perfectly complement modern LCD and Plasma screens.

If you require a wall mount that is reliable and robust, then look no further than the comprehensive Paramount range.

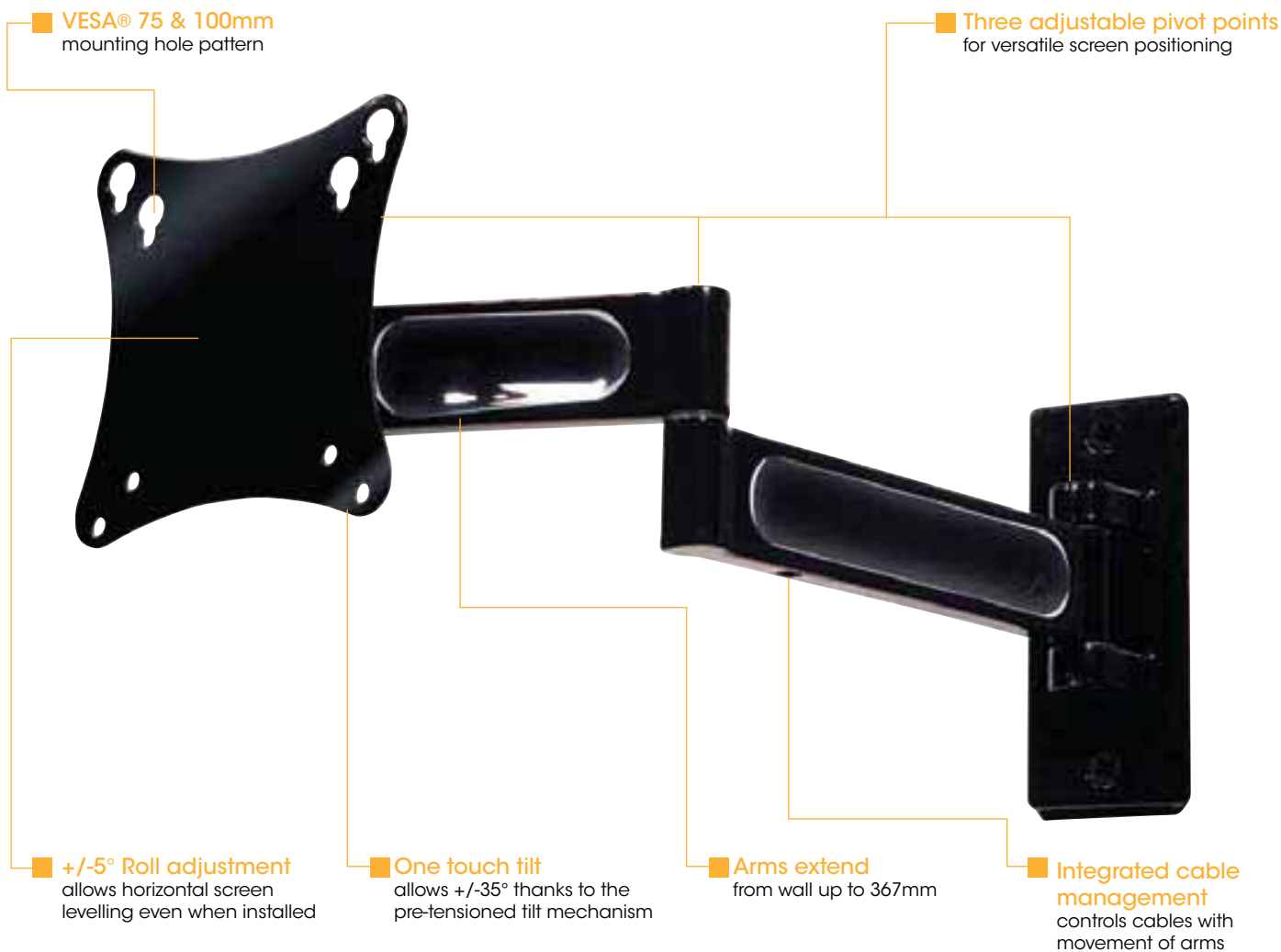

Dimensions & features relate to PA730 model as shown

Recommended Accessories

ACC918



Security fasteners for mounts with VESA® 75, 100, and 200x100 mounting patterns

ACC919



















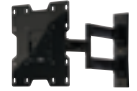



Security fasteners for mounts with up to VESA® 400x300 mounting patterns

ACC925



Security fasteners for all scalable wall mounts

	FLAT	TILT	FIXED TILT	PIVOT	ARTICULATING
SMALL Screen sizes 10-24" LCD	PF630 	PT630 		PP730 	PA730 
MEDIUM Screen sizes 22-40" LCD	PF632 	PT632 		PP740 	PA740 
MEDIUM/LARGE Screen sizes 23-46" LCD	PF640 	PT640 	PFT640 		
LARGE Screen sizes 32-56" LCD/Plasma	PF650 	PT650 		PA760 	
X-LARGE Screen sizes 37-60" LCD/Plasma	PF660 	PT660 	PFT660 		

Part No.	Screen sizes	Max. weight	Tilt	Pan	Roll	Arm extension	Mounting pattern
PF630	10-24"	36kg (80lbs)	n/a	n/a	n/a	n/a	VESA 75 & 100
PT630	10-24"	36kg (80lbs)	+15/-5°	n/a	n/a	n/a	VESA 75 & 100
PP730	10-24"	11kg (25lbs)	±35°	±90°	±5°	178mm	VESA 75 & 100
PA730	10-24"	11kg (25lbs)	±35°	±90°	±5°	367mm	VESA 75 & 100
PF632	22-40"	52kg (115lbs)	n/a	n/a	n/a	n/a	VESA 75, 100, 200x100, 200x200
PT632	22-40"	52kg (115lbs)	+15/-5°	n/a	n/a	n/a	VESA 75, 100, 200x100, 200x200
PP740	22-40"	36kg (80lbs)	+15/-5°	±90°	±7°	207mm	VESA 75, 100, 200x100, 200x200
PA740	22-40"	36kg (80lbs)	+15/-5°	±90°	±7°	396mm	VESA 75, 100, 200x100, 200x200
PF640	23-46"	68kg (150lbs)	n/a	n/a	n/a	n/a	Universal up to 438x329mm
PT640	23-46"	68kg (150lbs)	+15/-5°	n/a	n/a	n/a	Universal up to 446x329mm
PFT640	23-46"	45kg (100lbs)	0, 2, 5 & 10°	n/a	n/a	n/a	Universal up to 453x329mm
PF650	32-56"	80kg (175lbs)	n/a	n/a	n/a	n/a	Universal up to 730x433mm
PT650	32-56"	80kg (175lbs)	+15/-5°	n/a	n/a	n/a	Universal up to 738x449mm
PF660	37-60"	91kg (200lbs)	n/a	n/a	n/a	n/a	Universal up to 730x433mm
PT660	37-60"	91kg (200lbs)	+15/-5°	n/a	n/a	n/a	Universal up to 738x449mm
PFT660	37-60"	80kg (175lbs)	0, 2, 5 & 10°	n/a	n/a	n/a	Universal up to 828x433mm
PA760	37-60"	59kg (130lbs)	+15/-5°	±45°	n/a	410mm	Universal up to 699x432mm

ONEMount® wall mount

- Design expands mount to accommodate 23 to 84" LCD or Plasma screens (one, two or three plate configurations)
- Horizontal screen adjustment up to 203mm (8")
- One touch tilt allows adjustment of +15/-5° without the use of tools with optional tilt lock in 5° increments
- Easy glide design ensures screen is securely attached to wall plate
- Portrait orientation for up to 50" screens (maximum hole pattern of 673x432mm (w x h))
- Supplied with M10 screen adaptors for complete screen compatibility
- Black finish



3 - plate configuration

Recommended Accessories: ACC925 Security fasteners - see pages 16 & 18

Technical Specifications				
Part No.	Screen Size	Colour	Max. weight	Mounting pattern
ONE-TP	23-84"	Black	113kg (250lbs)	Universal (up to 1036 x 673mm)

Portrait & landscape wall mounts

Tilting - ST16D

- For use with PLP-UN-1 universal adaptor ideally suited for flat panel screens 32-50", up to 57kg in weight and 701x400mm mounting pattern (not included)
- One touch tilt allows adjustment of +15/-5° without the use of tools with optional tilt lock in 5° increments
- Measures 76mm (3") from wall plus thickness of adaptor plate
- Easy glide design ensures screen is securely attached to wall plate
- Supplied with 489mm (19.25") wide wall plate, ideal for portrait style installations
- Black finish

Flat to wall - SF16D

- For use with PLP-UN-1 universal adaptor ideally suited for flat panel screens 32-50", up to 57kg in weight and 701x400mm mounting pattern (not included)
- Measures 30mm from wall plus thickness of adaptor plate
- Horizontal screen adjustment of up to 15cm (6")
- Easy glide design ensures screen is securely attached to wall plate
- Supplied with 489mm (19.25") wide wall plate, ideal for portrait style installations
- Includes theft resistant hardware for attaching screen to mount
- Black finish



Technical Specifications			
Part No.	Screen Size	Max. weight	Mounting pattern
SF16D	32-50"	57kg (125lbs)	Requires PLP-UN-1 adaptor
ST16D	32-50"	57kg (125lbs)	Requires PLP-UN-1 adaptor
PLP-UN-1	32-50"	57kg (125lbs)	Universal up to 701 x 400mm

Pull-out swivel wall mounts

- Ideal product for digital signage and hospitality applications (i.e., video wall) where screen must be recessed
- Suited for LCD & Plasma screens from 32 to 58"
- Arms extend up to 273mm (10.25") from wall
- Pull-out swivel with up to 90° rotation (±45° left or right)
- 0, 5 or 10° lockable tilt
- Integrated cable management
- ±1° roll for horizontal screen alignment during installation
- Locking tab included for optional swivel restriction to one side
- Lock Key™ installation tool securely extends arms for screen installation
- Black finish



Technical Specifications				
Part No.	Screen Size	Colour	Max. weight	Mounting pattern
SP850-UNL	32-58"	Black	68kg (150lbs)	Universal up to 729 x 432mm

Corner Mounts

- Allows screen to fit in a corner where space is limited
- CM850 model includes SP850-UNL pull-out swivel mount - (see left for full details)
- CM50 wall units expand to support compatible flat-to-wall or tilting wall mounts for LCD and Plasma screens 32-50" in size (sold separately)
- CM60 includes additional support plate to accommodate compatible flat-to-wall or tilting wall mounts for LCD and Plasma screens 40-60" in size
- Wall units accommodate speakers when used with smaller screens (wall unit may be visible with some smaller screens)
- Optional shelf (ACC324) available for AV components



Technical Specifications				
Part No.	Screen Size	Colour	Max. weight	Mounting pattern
CM850	32-58"	Black	68kg (150lbs)	Universal up to 729 x 432mm
CM50	32-58"	Black	79kg (175lbs)	Requires wall mount (sold separately)
CM60	40-60"	Black	91kg (200lbs)	Requires wall mount (sold separately)

In wall mounts & boxes

- Installs between 16" wood stud centres
- Stud locating tabs adjust 6.35mm (1/4") left or right to accommodate stud spacing
- IM740P model includes SA740P articulating mount for up to 40" LCD screens (see page 13)
- IM760PU models mount 32" to 71" LCD or plasma screens
- Removable mains plug cover and cable management access plates make installation simple
- Black finish



Technical Specifications				
Part No.	Screen Size	Colour	Max. weight	Mounting pattern
IM740P	22-40"	Black	36kg (80lbs)	VESA 75, 100, 200x100, 200x200
IM760PU	32-71"	Black	91kg (200lbs)	Universal up to 729x432mm

Menu board mount

- Designed to support two or more screens in portrait or landscape orientation
- Perfectly aligns multiple horizontal screens without the need for complicated measurements
- Flat or tilt screen mounting option available - with tilt of +15° and -5° for ideal viewing angle even when installed above head height
- Expandable with attachment points to accommodate additional screens
- Cable management accessory included for a clean clutter-free installation
- Optional component storage available, DS578
- Menu board mount configurator available to create specific menu board system for 2 screens or more, in either portrait or landscape orientation, using the least number of components

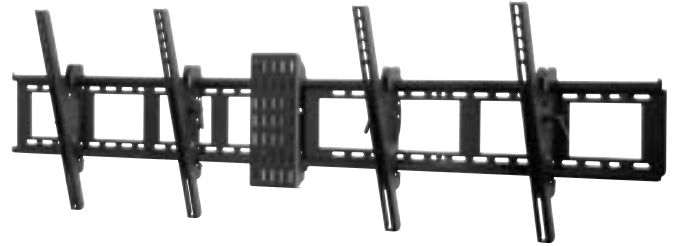

Technical Specifications				
Part No.	Screen Size	Colour	Max. weight	Mounting pattern
DS135	23-71"	Black	150kg (350lb)	Up to 890 x 449mm

Tilt wall mount with content box storage

- Houses media controller, graphics driver or computer up to:
DS508: 378 x 100 x 338mm (WxDxH)
DS509: 378 x 51 x 229mm (WxDxH)
- Provides ventilation space to keep computer at optimal temperature
- Media controller, graphics driver or computer can be removed and serviced without the removal of the screen
- Internal cable management hides cables for a clean, clutter-free appearance
- 'Kick-stand' feature props screen upwards enabling easy access to cables and for maintenance

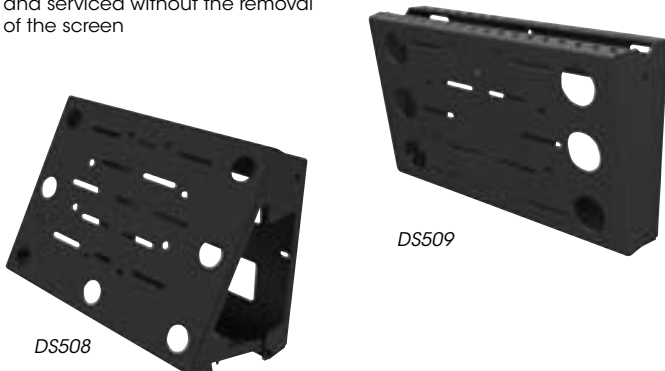

Technical Specifications				
Part No.	Screen Size	Colour	Max. weight	Mounting pattern
DS508	32-60"	Black	91kg (200lbs)	VESA 100x100, 200x100, 100x200, 200x200mm
DS509	32-60"	Black	91kg (200lbs)	VESA 100x100, 200x100, 100x200, 200x200mm

Video Wall full-service mount

- Easy pull-out / prop open mechanism for quick service access
- Spring loaded return mechanism clicks display securely back into place
- Release cables allow screens in the middle of a video wall to be accessed for installation and maintenance
- Inter-connect design allows creation of unlimited video wall display configurations
- VESA 200x200mm up to 600x400mm compliant in 100mm increments
- Custom wall plate spacers eliminate on-site guesswork and screen spacing calculations



Technical Specifications			
Part No.	Screen Size	Max. weight	Mounting pattern
VW-760	40-65"	68kg (150lb)	Universal up to 600 x 400mm

Modular Series flat panel screen kit

NEW



Peerless constantly strives to improve the versatility and ease of use of our products, and having listened to the feedback from installers and integrators it is apparent that the market requires a product range that can fulfil multiple requirements from a limited number of SKUs. Thus the Modular Series has been introduced as a universal ceiling mount solution with just over a dozen components in the range.

Developed particularly for professional AV applications the Modular System is designed and manufactured in the UK from the same high quality materials as all Peerless mounts for the assurance of durability. For peace of mind all products are tested to the highest UL safety standards and include a number of innovative features and benefits specific to flat panel mounting, such as fixed tilt and multiple screen options, making them the most versatile and easy to install products available.

MOD-FPSKIT150 1.5m flat panel ceiling mount kit

Kit includes:

- 1 x MOD-CPC:** Cathedral ceiling plate
- 1 x MOD-P150:** 1.5m chrome pole
- 1 x MOD-FPMS:** Single flat panel mount
- 1 x MOD-UNL:** Large universal adaptor

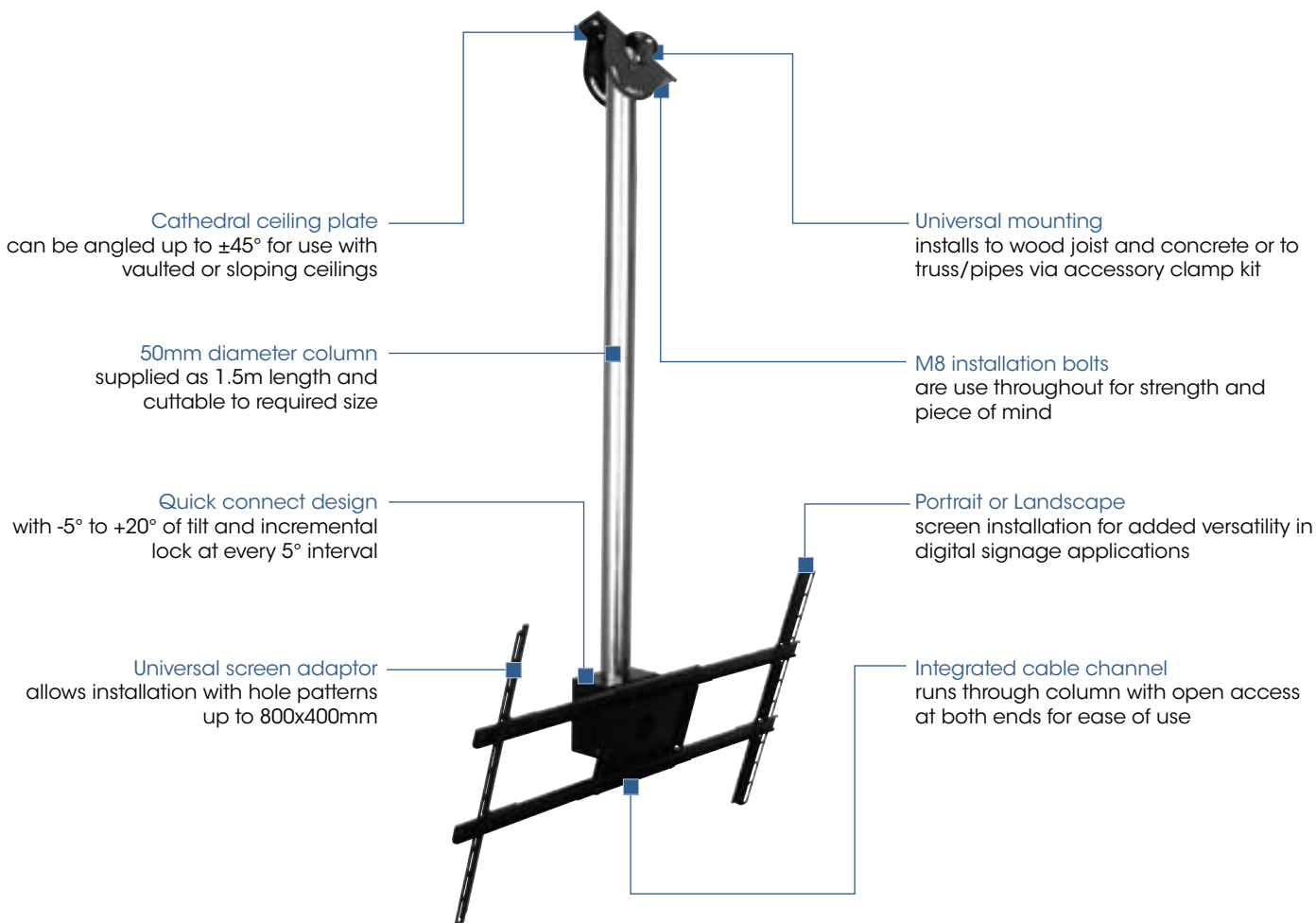

1 Choose the ceiling plate

Heavy Duty Ceiling Plate MOD-CPF



Mounts to concrete and wood joist ceilings
Max Weight: 170kg (374lbs)

Cathedral Ceiling Plate MOD-CPC



Mounts to concrete and wood joist ceilings
Tilt: +/- 60° Max Weight: 120kg (264lbs)

I-Beam Ceiling Plate MOD-CPI



Fully adjustable for I-beams 85mm to 250mm wide
Tilt: +/- 60° Max Weight: 120kg (264lbs)

U-Bolt Accessory Kit MOD-AUB



Clamps around 40mm to 85mm (1.5-3.3") diameter pipes, trusses etc.
Adapts to MOD-CPC & MOD-CPF
Max Weight: 120kg (264lbs)

2 Select the pole length & Screen stacking

Extension Poles

MOD-P150: 1.5m (59") length (Chrome) MOD-P300: 3.0m (118") length (Chrome)



Cutttable to desired length **Diameter:** 50.8mm (2")

Screen-Stacking Clamp

MOD-ASC

Clamps around extension pole to stack multiple single or dual back-to-back screens
Max Load: 85kg (187lbs)



3 Screen configuration adaptor

Single Screen Mount MOD-FPMS



Screen Size: 10" to 65" (depending on screen adaptor)
VESA Pattern: 75/100 compliant
Max Weight: 100kg (220lbs)
Tilt: +20/-5° **Swivel:** 360°

Back-to-Back Screen Mount MOD-FPMD



Screen Size: 10" to 65" (depending on screen adaptor)
VESA Pattern: 75/100 compliant
Max Weight: 170kg (374lbs)
Tilt: +20/-5° **Swivel:** 360°

4 Required screen mount

Large Universal Adaptor MOD-UNL



Screen Size: 32"-60" flat panel screens
VESA Pattern: Up to 700x400 (WxH)
Max Weight: 60kg (132lbs)

Medium Universal Adaptor MOD-UNM



Screen Size: 26"-46" LCD screens
VESA Pattern: Up to 450x400 (WxH)
Max Weight: 60kg (132lbs)

Security Fastener Pack ACC-918



For use with MOD-FPMS & MOD-FPMD
Screen Size: 10"-24" LCD screens
VESA Pattern: Compatible with VESA 75/100 mounting pattern

VESA 200x100 Adaptor ACC-V2x1



For use with MOD-FPMS & MOD-FPMD
Screen Size: up to 26" **VESA Pattern:** 200x100
Max Weight: 30Kg (66lbs)

VESA 200x200 Adaptor ACC-V2x2



Screen Size: Up to 37" **VESA Pattern:** 200x200, 200x100
Max Weight: 30kg (66lbs)

VESA 400x300 Adaptor ACC-V4x3

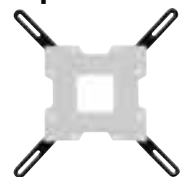

For use with ACC-V2x2 mounting plate
Screen Size: Up to 37" **VESA Pattern:** 300x200, 300x300, 400x200, 400x300, up to M6 screws
Max Weight: 30kg (66lbs)

Ceiling mounts for LCD screens



- VESA 75 and 100 compliant for LCD screens 15-24"
- Ideal for flat finished concrete or wood joist ceilings
- Adjustable extension length (see table below)
- Continuous tilt of +15°/-5° with optional lock in 5° increments
- Internal cable management within extension channels for clean, clutter free appearance
- Safety catch designed into extension channels to ensure user and equipment safety
- Works with standard 102mm (4") loops for use with round, square, rectangular or I-beam truss up to 76 x 89mm (3 x 3.5")
- Available in black, silver (-S) or white (-W) finishes

Ceiling mount extension length

- **PC930A:** 246-353mm (9.7-13.9")
- **PC930B:** 350-556mm (13.8-21.9")
- **PC930C:** 514-864mm (20.2-34")

Technical Specifications

Part No.	Screen sizes	Extension	Colour	Max. weight	Mounting pattern
PC930A	15-24"	246-353mm (9.7-13.9")	Black, Silver or White	23kg (50lbs)	VESA 75, 100
PC930B	15-24"	350-556mm (13.8-21.9")	Black, Silver or White	23kg (50lbs)	VESA 75, 100
PC930C	15-24"	514-864mm (20.2-34")	Black, Silver or White	23kg (50lbs)	VESA 75, 100

Ceiling mounts for LCD screens



- VESA 75, 100, 200x100mm and 200x200mm compliant for LCD screens 15-37"
- Ideal for flat finished concrete or wood joist ceilings
- Adjustable extension length (see table below)
- Continuous tilt of +15°/-5° with optional lock in 5° increments
- Internal cable management within extension channels for clean, clutter free appearance
- Safety catch designed into extension channels to ensure user and equipment safety
- Works with standard 102mm (4") loops for use with round, square, rectangular or I-beam truss up to 76 x 89mm (3 x 3.5")
- Available in black, silver (-S) or white (-W) finishes

Ceiling mount extension length

- **PC932A:** 246-353mm (9.7-13.9")
- **PC932B:** 350-556mm (13.8-21.9")
- **PC932C:** 514-864mm (20.2-34")

Technical Specifications

Part No.	Screen sizes	Extension	Colour	Max. weight	Mounting pattern
PC932A	15-37"	246-353mm (9.7-13.9")	Black, Silver or White	36kg (80lbs)	VESA 75, 100, 200x100, 200x200
PC932B	15-37"	350-556mm (13.8-21.9")	Black, Silver or White	36kg (80lbs)	VESA 75, 100, 200x100, 200x200
PC932C	15-37"	514-864mm (20.2-34")	Black, Silver or White	36kg (80lbs)	VESA 75, 100, 200x100, 200x200

Multi display ceiling mounts

A fully flexible system for mounting multiple flat panel displays, the Peerless Multi Display system allows you to ceiling mount up to four LCD or Plasma screens in a variety of configurations. Whether your requirement is for an in-line, circular or curved array of displays, Peerless has the solution.

Circular configuration



Curvilinear configuration

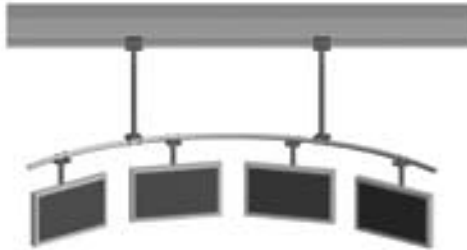

In-line configuration



For more information contact the Peerless-AV sales team on +44 (0) 1923 200 100

Custom mount

- Return-to-Zero™ capability allows the screen to return to original position if accidentally rotated or bumped
- Designed to accommodate a variety of add-on peripherals
- Cover conceals and protects screen and peripherals
- Internal cable management hides cables for a clean, clutter-free appearance

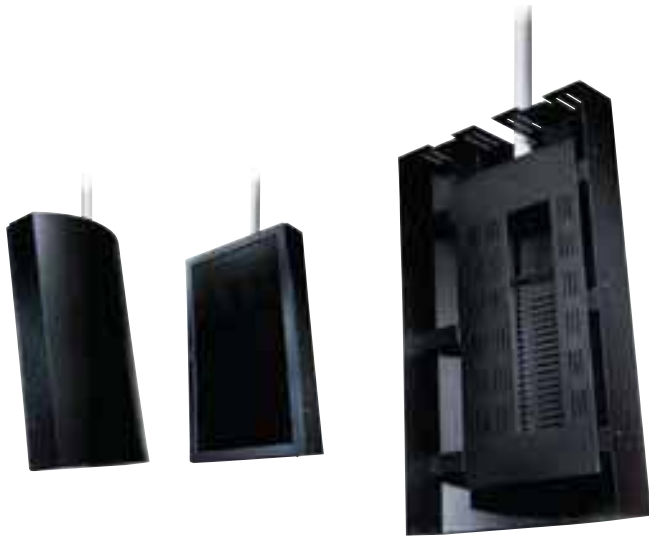

Technical Specifications				
Part No.	Screen Size	Colour	Max. weight	Mounting pattern
DS1-SW42	42"	Black	68kg (150lbs)	Screen specific

Bespoke for Panasonic 85"

- Designed exclusively to accommodate Panasonic 85-inch flat panel screens
- Keyhole slots provide quick and easy installation
- Tilts to 5°, 10°, 15° or 20° for optimal viewing angle at any mounting height
- Convenience of full 360° swivel for perfect positioning



Technical Specifications				
Part No.	Screen Size	Colour	Max. weight	Mounting pattern
PANA-85CEIL	85" Pana	Black	136kg (300lbs)	Bespoke

Articulating desktop mount for LCD screens



- Suitable for desk mounting LCD screens 10-22" in size
- Three pivot points with up to 360° pan, ±60° tilt
- Includes extension arm
- Mounting options for all surfaces (desk clamp and desk bolt) included
- Up to 360° roll adjustment allows screen to be displayed in landscape or portrait orientation
- Compact retractable design increases workspace
- Durable gas strut and ball-joint system for smooth, stable operation
- Die cast aluminium construction
- Black finish

Technical Specifications			
Part No.	Screen Size	Max. weight	Mounting pattern
LCT-101	10-22"	11kg (25lbs)	VESA 75, 100

Desktop multiple screen mount



- Suitable for desk mounting two, three or four LCD screens 10-22" in size
- Adjustable crossing and ball joint design allows maximum screen fitting flexibility
- Ball joint system delivers maximum individual screen pan, tilt and rotation adjustment
- Supports LCD screens up to 11kg (25lbs) per screen
- Mounting options for all surfaces – clamp, bolt and free-standing desk base (each sold separately)
- Integrated cable management for a clean and tidy appearance
- Strong and attractively styled die cast aluminium construction
- Black finish

Required Accessories



Technical Specifications			
Part No.	Screen Size	Max. weight	Mounting pattern
LCT-102	2 x 10-22"	2 x 11kg (25lbs)	VESA 75, 100
LCT-103	3 x 10-22"	3 x 11kg (25lbs)	VESA 75, 100
LCT-104	4 x 10-22"	4 x 11kg (25lbs)	VESA 75, 100

Desktop swivel mount for LCD screens

- Ideally suited for LCD screens 22-40" in size
- 30° of swivel to each side (60° in total)
- Height adjustment from 399mm to 553mm, adjustable in 38mm (1.5") increments
- Bolt down mount for secure attachment
- Supplied with security screws
- Accommodates VESA@ 100, 200x100 and 200x200 mounting patterns
- Maximum load capacity 36kg (80lbs)
- Black finish



Technical Specifications

Part No.	Screen Size	Max. weight	Mounting pattern
HP432-002	22-40"	36kg (80lbs)	VESA 100, 200x100 and 200x200

Desktop swivel mount for 32-50" screens

- Built in swivel up to 360° allows for optimum viewing angle
- Free standing base bolts down for safety and security
- Adjustable height allows for greater flexibility
- Cable management internally through the mount and down through the mounting surface
- Decorative base is aesthetically pleasing and hides desktop mounting hardware
- Security screws prevent tampering and theft
- Built-in universal and VESA adaptor plate



Technical Specifications

Part No.	Screen Size	Colour	Max. weight	Mounting pattern
HP450	32-50"	Black	68kg (150lbs)	Universal

Desktop swivel mount for 32" screens

- Built in swivel up to 360° allows for optimum viewing angle
- Free standing base bolts down for safety and security
- Adjustable height allows for greater flexibility
- Cable management internally through the mount and down through the mounting surface
- Built in adaptor plate is VESA 200x200mm compatible
- Decorative base is aesthetically pleasing and hides desktop mounting hardware
- Security screws prevent tampering and theft



Technical Specifications

Part No.	Screen Size	Colour	Max. weight	Mounting pattern
HP432-B	26-32"	Black	36kg (80lbs)	VESA 200x100

Desktop swivel mount for 37 & 42" LG TVs

- For LG LCD models 37LC5DC and 42LC5DC
- Built in swivel up to 360° allows for optimum viewing angle
- Free standing base bolts down for safety and security
- Adjustable height allows for greater flexibility
- Cable management internally through the mount and down through the mounting surface
- Decorative base is aesthetically pleasing and hides desktop mounting hardware
- Security screws prevent tampering and theft



Technical Specifications

Part No.	Screen Size	Colour	Max. weight	Mounting pattern
HP442-B	37-42"	Black	36kg (80lbs)	VESA 600x400

Lock down plate for TV base stand

- Plate quickly attaches to bottom of screen base
- Security hardware and VHB tape options for attaching the base to the desktop surface
- Slim, low-profile hides plate from view
- 1" of front to back adjustment
- Includes all necessary mounting hardware



Technical Specifications

Part No.	Screen Size	Colour	Max. weight	Mounting pattern
HLG452-001 (Qty 10)	26-52"	Black	45kg (100lbs)	-
HLG452-002 (Qty 10)	26-52"	Black	45kg (100lbs)	-
HLG452-003	26-52"	Black	45kg (100lbs)	-

Lock down kit for TV base stand

- Securely mounts screen base to most surfaces with tamper-resistant hardware
- Low profile clips remain hidden when installed



Technical Specifications

Part No.	Screen Size	Colour	Max. weight	Mounting pattern
FLD-UNV-S	22-42"	Silver	45kg (100lbs)	-

Trolleys & Stands for LCD and Plasma screens



Trolleys - SR560

- Ideally suited for 32-60" LCD and Plasma screens
- Incremental tilt angle (-2, 0, +5°) together with continuous height adjustment on 1.66m (65") column for optimum viewing position
- 100mm swivel castors allow for easy movement and trolley positioning (two locking castors)
- Adjustable tempered glass (SR560G) or metal shelf (SR560M) to hold AV equipment and accessories
- Internal cable management
- Black finish
- Total maximum load (screen + shelves) 114kg (250lbs)

Stands - SS550

- Designed to complement the look of any room
- Incremental tilt angle (-2, 0, +5°) together with continuous height adjustment on 1.46m (57.6") column for optimum viewing position
- Adjustable tempered glass shelves to support AV equipment and accessories
- Internal cable management
- Stand available in high gloss black or silver (-S) finishes
- Total maximum load (screen + shelves) 114kg (250lbs)
- Black finish

Technical Specifications

Part No.	Screen size	Shelf	Stand colour	Max. weight	Mounting pattern
SR560G	32-60"	Glass	Black	68kg (150lbs) screen, 23kg (50lbs) per shelf	Universal up to 730x433mm
SR560M	32-60"	Metal	Black	68kg (150lbs) screen, 23kg (50lbs) per shelf	Universal up to 730x433mm
SS550P	32-50"	2 x tinted shelves	Black	68kg (150lbs) screen, 23kg (50lbs) per shelf	Universal up to 730x433mm

Base shelf

- For SR560 LCD/Plasma trolleys
- Additional storage space for PC or larger components
- Designed with slots for safety belt ACC316 to secure equipment
- Black finish



Technical Specifications

Part No.	Colour	For use with	Max. weight
ACC315	Black	SR560 trolley	23kg (50lbs)

Video conferencing shelf

- Mounts direct to top of SR560 trolley or SS550P stand
- Adjusts in height along with screen
- Black finish



Technical Specifications

Part No.	Colour	For use with	Max. weight
ACC319	Black	SR560 trolley SS550P stand	23kg (50lbs)

Metal shelf

- Metal shelf mounts direct to column of SR560 LCD/Plasma trolleys
- Installs above or below flat panel screen
- Holds AV or computer equipment
- Designed with slots for safety belt ACC316
- Black finish



Technical Specifications

Part No.	Colour	For use with	Max. weight
ACC313	Black	SR560 trolley	23kg (50lbs)

Laptop arm

- Metal shelf mounts direct to column of SR560 LCD/Plasma trolleys
- Supports laptop
- Vertical height and 180° swivel adjustment
- Quick release for easy height adjustment
- Black finish



Technical Specifications

Part No.	Colour	For use with	Max. weight
ACC314	Black	SR560 trolley SS550P stand	4.5kg (10lbs)

Tempered glass shelves

- Tempered glass shelf designed to support AV components and accessories
- Attaches directly to SR560 trolleys and SS550P stand



Technical Specifications

Part No.	Colour	For use with	Max. weight
ACC318-GB	Tinted glass shelf, gloss black brackets	SR560 trolley SS550P stand	23kg (50lbs)

Stands for LCD/Plasma screens



- Ideally suited for 32-60" (FPZ-600) or 50-71" (FPZ-670) LCD and Plasma screens
- VESA 100, 200x100mm and 200x200mm compliant
- Supports non VESA screens with additional PLP screen adaptor (sold separately)
- Internal cable management for a clean and tidy appearance
- Height adjustable on 1.8m (6') poles
- Screen(s) can be positioned in landscape or portrait orientation
- Hook-on design allows screen to rest in place while screen is being secured
- **FPZ-600**: fits single or back-to-back LCD or Plasma screens (up to four screens with additional ACC604 cartridge, sold separately)
- **FPZ-670** fits two 50-71" screens back-to-back with base cover designed to conceal AV source, surge protector etc.
- Black finish

Recommended Accessories

ACC604
Additional dual screen mount

PLP-UNL/PLP-UN-1
Universal adaptors



see page 34

Technical Specifications

Part No.	Screen Size	Colour	Max. weight	Mounting pattern
FPZ-600	32-60"	Black	91kg (200lbs) per screen up to 4 screens	VESA 100, 200x100, 200x200. Universal screen adaptor sold separately
FPZ-670	50-71"	Black	91kg (200lbs) per screen up to 2 screens	VESA 100, 200x100, 200x200. Universal screen adaptor sold separately

Pratico flat panel stand

- Ideally suited for LCD and Plasma screens up to 42"
- VESA 75, 100, 200x100 and 200x200mm compliant
- Collapsible design allows legs to fold for easy transporting and storage
- Integrated cable management to simply route unsightly cables through main column
- Height adjustability in 25mm (1") increments for ideal screen positioning from 1233 to 1633mm (48.5" - 64.3")



Recommended Accessories



ACC330
AV Component shelf

Technical Specifications

Part No.	Screen Size	Colour	Max. weight	Mounting pattern
FPZ-640	Up to 42"	Black	50kg (110lbs)	VESA 75, 100, 200x100, 200x200

Pedestal mounts for LCD & Plasma screens

- Choice of four different pedestal heights from 1.5m to 2.4m
- 15° forward tilt for viewing flexibility
- 360° pan with swivel stop
- Screen can be changed from landscape to portrait orientation without having to remove the screen
- Internal cable management
- Concrete floor anchors included
- Requires screen adaptor (sold separately)



Required Accessories



PLP-UNL/PLP-UN-1
universal adaptor brackets
- see page 34

Technical Specifications

Part No.	Screen Size	Colour	Max. weight	Overall Height
COL510P	32-50"	Black	68kg (150lbs)	1524mm (5')
COL610P	32-50"	Black	68kg (150lbs)	1829mm (6')
COL710P	32-50"	Black	68kg (150lbs)	2133mm (7')
COL810P	32-50"	Black	68kg (150lbs)	2438mm (8')

Cable Management Column

- Perfect to conceal unsightly cables from wall mounted flat panels
- Can also be used for video conferencing applications
- 300mm (12") column with ample space for all AV cables
- Design allows multiple columns to be joined
- Low profile at only 38mm (1.5") from the wall
- Available in black or silver finish



Technical Specifications			
Part No.	Colour	Length	Depth from wall
ACWAC1/BK	Black	300mm (12")	38mm (1.5")
ACWAC1/SI	Silver	300mm (12")	38mm (1.5")

AV Component Shelf

- Designed to work with Peerless Cable Management Column for a complete AV support system
- Shelf fully adjustable along column length for ideal positioning
- Perfect for domestic or corporate video conferencing applications
- Suitable for AV components up to 10kg (22lbs) in weight
- Toughened glass shelf for added safety
- Overall size 419mm x 304mm (16.5" x 12") W x D



Technical Specifications			
Part No.	Colour	Max. weight	Overall size
ACWAS1/BK	Black	10kg (22lbs)	419 x 304mm

Cable management channels

- Keeps cables and power cords out of sight for a clean and professional appearance
- Paintable surface to match any environment
- 1.4m (4.5') long with the ability to be customised to desired length
- Measures 27mm (1.05") from wall for a low profile installation
- 90° corner connector to route cables to the side
- Wall attachment clips designed with integrated channels to keep cables in place
- Available in black or white (-W)



Technical Specifications		
Part No.	Colour	Dimensions (w x d x h)
PCC	Black	79 x 27 x 1371mm

Adjustable shelf for AV components

- Versatile design ideal for stacking multiple AV components
- Adjustable width and depth
- Snap-on cover hides wall plate and mounting hardware
- Adjustment control allows for simple levelling of components
- Embossed arms with screw holes secure components to shelf
- 45kg load capacity allows stacking of multiple components
- Black finish



Technical Specifications			
Part No.	Colour	Max. weight	Width range, depth range
PS200	Black	45kg (100lbs)	405-468mm, 377-584mm

Camera mount

- Ball and socket for 360° pan and 90° tilt for positioning direction of camera
- 178mm (7") arm extension
- Can be wall or ceiling mounted
- Engineered plastic eliminates electrical grounding problems
- Single point adjustment control
- Cable management routing channel
- Patented design



Technical Specifications			
Part No.	Colour	Tilt, Pan	Max. weight
CMR410	Light grey	90°, 360°	4.5kg (10lbs)

Universal speaker mounts

- Mounts to wall or ceiling with 57mm (2.25") ceiling extension
- Simple tilt, pivot and rotation adjustment
- 1, 2 and 4 hole mounting adaptors accommodate speakers with keyhole and threaded inserts
- Also available in white (-W)
- Available in pairs (PSP2) or pack of 5 (PSP5)
- Ball and socket design provides 60° rotation in any direction
- Flush mounted or for use with 75mm (3") extensions
- Includes fittings for mounting most commercially available speakers
- Internal speaker cable management



Technical Specifications				
Part No.	Colour	Tilt, Pan, Roll	Max. weight	Mounting pattern
PSP2	Black	±90°, 360°, 360°	3.6kg (8lbs)	Universal - fits most brands
PSP5	Black	±90°, 360°, 360°	3.6kg (8lbs)	Universal - fits most brands
SPK811	Black	±60°, 360°, ±60°	9kg (20lbs)	Universal - fits most brands

Peerless Professional ceiling kits



Peerless offers a comprehensive range of ceiling mounts and accessories for projectors and flat panel screens for commercial and residential applications. In addition to the UK designed and manufactured 'Modular Series' (see pages 8-9 and 22-23) there is a dedicated range of Peerless Professional solutions to provide added choice and versatility in any installation.

A selection of ceiling plates engineered for specific ceiling type, such as wood joist, concrete and various others, is coupled with extension poles with threaded ends for quick and secure engagement. The system is completed by a range of adaptor & mounting solutions for projectors as well as single or dual flat panel screens, along with accessories to add the finishing touches.

Projector ceiling mount



Flat Panel ceiling mount

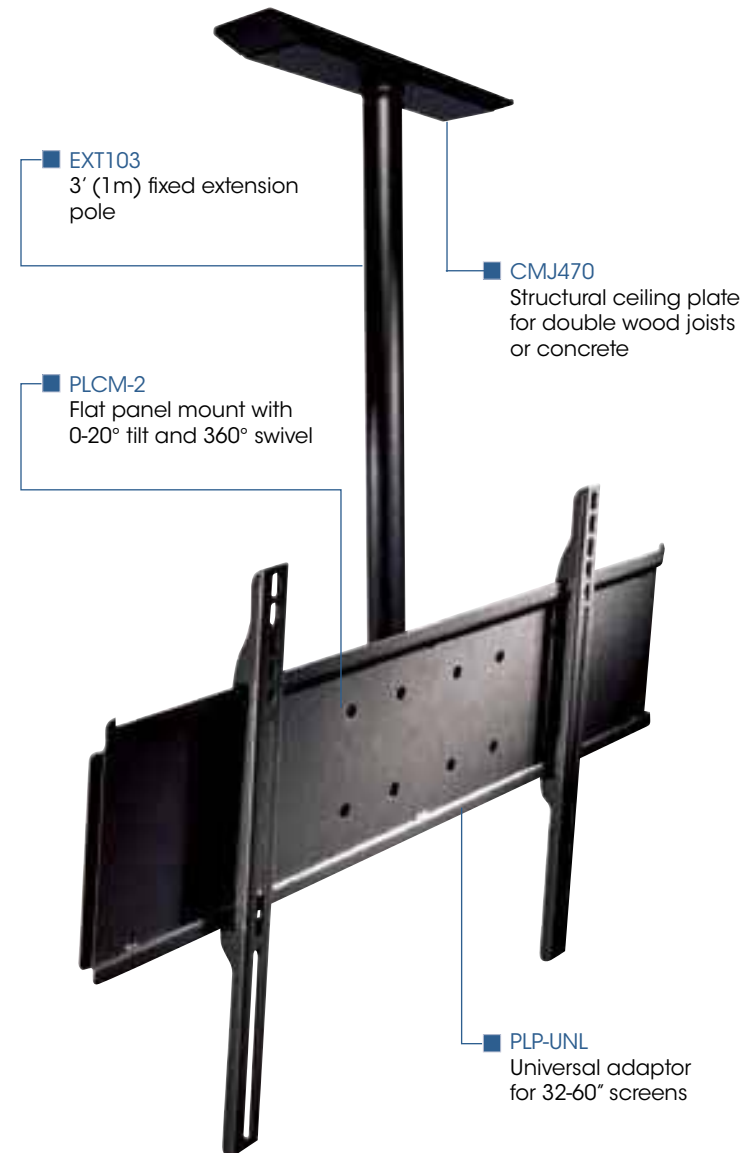

Ceiling plate for wood joists

- Mounts to wood joists on 400-440mm centres or structural concrete ceiling (requires concrete wall plugs, sold separately)
- For use with Peerless ceiling mounts & projector mounts
- Compatible with Peerless extension poles
- Black finish

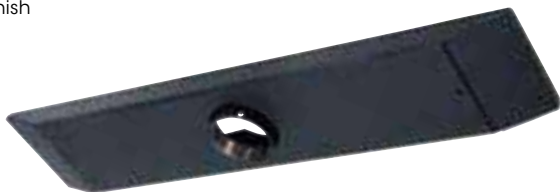

Technical Specifications

Part No.	Colour	Max. weight	Mounting pattern
CMJ470	Black	136kg (300lbs)	16" joist centres

Round ceiling plate

- Mounts to wood joist or structural ceiling
- Cable management access hole
- For use with Peerless ceiling mounts & projector mounts
- Compatible with Peerless extension poles
- Available in black, silver (-S) and white (-W) finishes



Technical Specifications

Part No.	Colour	Max. weight
ACC570	Black	68kg (150lbs)

Structural ceiling plate

- Mounts to wood joists, structural ceiling or concrete
- Low profile design ideal for small screens and projector installations
- For use with Peerless ceiling mounts & projector mounts
- Compatible with Peerless extension poles
- Black finish



Technical Specifications

Part No.	Colour	Max. weight
ACC560	Black	23kg (50lbs)

Cathedral ceiling plate

- Mounts to cathedral or vaulted ceilings
- 120° (±60°) of adjustment
- **ACC556**: heavy duty for up to 136kg (300lbs), available in white
- **ACC912**: compact, lightweight design handles up to 34kg (75lbs)

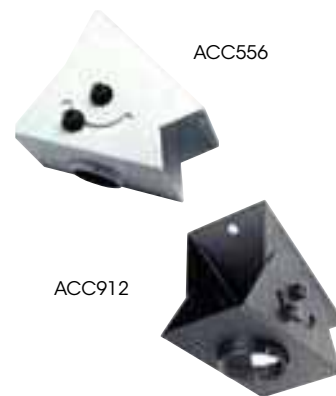

Technical Specifications

Part No.	Colour	Max. weight
ACC556	White	136kg (300lbs)
ACC912	Black	34kg (75lbs)

Anti-vibration ceiling plates

- Reduces vibrations that may cause internal damage to equipment and/or cause screen image to vibrate
- Features two cable management access holes
- For use with Peerless ceiling mounts & projector mounts
- Compatible with Peerless extension poles
- **ACC840**: for wood joist ceiling
- **ACC845**: for Unistrut® ceiling
- Black finish



Technical Specifications

Part No.	Colour	Max. weight	Mounting pattern
ACC840	Black	27kg (60lbs)	n/a
ACC845	Black	27kg (60lbs)	41x41mm (1 ⁵ / ₈ x 1 ⁵ / ₈ " 12 gauge Unistrut®

Unistrut® & structural ceiling plates

- Attaches directly to standard Unistrut (41x41mm - 1⁵/₈ x 1⁵/₈"²) or to solid structural ceiling
- Unistrut fittings and attachment hardware sold separately
- For use with Peerless ceiling mounts & projector mounts
- Compatible with Peerless extension poles
- Black finish



Technical Specifications

Part No.	Colour	Max. weight	Mounting pattern
CMJ300	Black	114kg (250lbs)	104mm spacing between slots
CMJ310	Black	114kg (250lbs)	208mm spacing between slots

Fixed length extension poles

- For use with Peerless ceiling plates, LCD/Plasma ceiling mounts and projector mounts
- Features safety notches on both ends to prevent accidental loosening of pole
- Extension column lengths measure 89mm (3.5") longer than stated drop to provide finished drop length for various mounts (e.g. EXT101 measures 394mm/15.5")



Technical Specifications			
Part No.	Drop	Colour	Max. weight
EXT002	Flush	Black	544kg (1200lbs)
EXT006	152mm (6")	Black	544kg (1200lbs)
EXT101	305mm (1')	Black	544kg (1200lbs)
EXT103	914mm (3')	Black	544kg (1200lbs)
EXT105	1524mm (5')	Black	544kg (1200lbs)
EXT110	3048mm (10')	Black	544kg (1200lbs)

Adjustable extension poles

- Features safety notches on both ends
- Height adjustment in 25mm (1") increments
- Notched adjustment design enables easy height adjustment and position locking



Technical Specifications			
Part No.	Drop	Colour	Max. weight
AEC0609	152-229mm (6-9")	Black	408kg (900lbs)
AEC12018	305-457mm (12-18")	Black	408kg (900lbs)
AEC18024	457-610mm (18-24")	Black	408kg (900lbs)
AEC0203	610-914mm (2-3')	Black	408kg (900lbs)
AEC0305	914-1524mm (3-5')	Black	408kg (900lbs)
AEC0406	1219-1829mm (4-6')	Black	408kg (900lbs)
AEC0608	1829-2438mm (6-8')	Black	408kg (900lbs)
AEC0810	2438-3048mm (8-10')	Black	408kg (900lbs)
AEC1012	3048-3658mm (10-12')	Black	408kg (900lbs)

Cable management wraps

- Self coiling design securely holds cable along extension pole
- Sections can be stacked to create longer lengths or cut to desired length
- **ACC852**: four 610mm (2') sections
- **ACC856**: four 1829mm (6') sections
- Available in black, silver (-S) or white (-W)



Technical Specifications		
Part No.	Colour	Quantity and length
ACC852	Black	4 x 610mm (2')
ACC856	Black	4 x 1829mm (6')

Extension pole coupler

- Two female connectors to join two extension columns to create a maximum length of 6m (20')
- For use with Peerless extension columns
- Security screws included



Technical Specifications			
Part No.	Connectors	Colour	Max. weight
ACC109	F to F	Black	544kg (1200lbs)

Extension pole connectors

- 38mm (1½") access hole for internal cable management
- For use with Peerless extension columns
- Security screws included
- **ACC800** model - one male and one female connection to provide internal cable management between extension column and mount/ceiling plate
- **ACC850** model - two female connectors to provide internal cable management and join two extension columns to create a maximum length on 6m (20')



ACC800



ACC850

Technical Specifications			
Part No.	Connectors	Colour	Max. weight
ACC800	M to F	Black	136kg (300lbs)
ACC850	F to F	Black	136kg (300lbs)

Threaded connector adaptor

- Threaded adaptor designed to provide compatibility between Paramount LCD and projector mounts (PC930/932, PPA/PPB/PPC), PRS and Peerless extension poles and ceiling plates
- Threaded connector used in ceiling installations to enable the use of multiple ceiling applications such as cathedral ceilings, I-beam and truss
- Increases drop length when used in conjunction with standard extension column
- Available in black, silver (-S) or white (-W) finish



Technical Specifications	
Part No.	Weight capacity
ACC575	36kg (80lbs)

Universal adaptor brackets for LCD/Plasma screens

- Compatible with most Peerless LCD/Plasma mounts (sold separately)
- Easy glide design ensures screen is securely attached to wall plate
- Durable heavy gauge steel construction
- Black finish
- Can be used for either portrait or landscape screen orientation (PLP-UN-1 only)



PLP-UNM



PLP-UN-1

Technical Specifications				
Part No.	Screen size	Colour	Max weight	Mounting pattern
PLP-UNM	23-46" LCD	Black	68kg (150lbs)	Universal up to 438 x 329mm
PLP-UNL	32-60" LCD/Plasma	Black	91kg (200lbs)	Universal up to 729 x 433mm
PLP-UN-1	32-50" LCD/Plasma	Black	57kg (125lbs)	Portrait or Landscape up to 701 x 400mm

Ceiling mounts for LCD/Plasma screens

- Entire unit pans 360° with stop feature
- 20° adjustable tilt
- Screens can be mounted in portrait or landscape orientation
- Requires extension pole adaptor and ceiling plate, each sold separately
- **PLCM-2:** suitable for 32-60" LCD or Plasma screen
- **PLB-1:** Suitable for two 32-50" LCD or Plasma screen (both screens recommended to be the same size)



PLCM-2



PLB-1

Technical Specifications				
Part No.	Screen Size	Colour	Max. weight	Mounting pattern
PLB-1	32-50"	Black	136kg (300lbs)	Screen adaptor sold separately
PLCM-2	32-60"	Black	102kg (225lbs)	Screen adaptor sold separately

Precision gear projector mount

- Precision gear-driven tilt and roll adjustments
- Gears lockable to deter tampering
- Quick release for fast installation and maintenance
- Universal mounting pattern (up to 448mm)
- 23kg (50lbs) max weight capacity
- Tilt: +20° Swivel: 360° Roll: ±10°
- Flush mountable or drop mount using extension pole and ceiling plate



Technical Specifications				
Part No.	Tilt/Pan/Roll	Colour	Max. weight	Mounting pattern
PRG-UNV	±20°, 360°, ±10°	Black	23kg (50lbs)	Universal (up to 448mm)

PRS projector mount

- Independent and secure adjustment points
- Quick-release for fast adjustment and maintenance
- Universal mounting pattern (up to 448mm)
- 11kg (25lbs) max weight capacity
- Tilt: +20/-5° Swivel: 360° Roll: ±10°
- Flush mountable or drop mount using extension pole and ceiling plate



Technical Specifications				
Part No.	Tilt/Pan/Roll	Colour	Max. weight	Mounting pattern
PRS-UNV	+20°/-5°, 360°, ±10°	Black	11kg (25lbs)	Universal (up to 448mm)

AV Furniture



Choosing the right piece of AV furniture for your screen is as much a matter of personal taste as it is a question of functionality and space. An AV stand will not only enhance the appearance of your TV but should also complement your home surroundings.

Peerless makes the decision simple by offering a comprehensive range of different models with each style available in a choice of widths to perfectly complement the size of your screen.

Peerless has a wide range of AV support solutions and the above represents only some of the range highlights. Contact Peerless-AV UK for a dedicated furniture brochure or visit www.peerless-av.co.uk for more information.

Manhattan & Manhattan Corner



- Award winning design voted "Best AV Furniture" by Home Cinema Digest
- High gloss finish on side panels to complement screen design
- Toughened safety glass shelves for increased support and security
- Available in 3 sizes - 800mm & 1200mm flat-to-wall models and 1000mm corner design

Broadway



- Durable black finish with glass top cover for added protection
- Adjustable middle shelf for versatile AV component storage
- Available in 2 sizes - 900mm & 1100mm models for screens up to 42" and 50" respectively

Portland



- Natural Walnut finish side panels to complement modern interiors
- Metal frame construction for increased rigidity and weight capacity
- Available in 2 sizes - 900mm & 1100mm models for screens up to 42" and 50" respectively

AV Connectivity

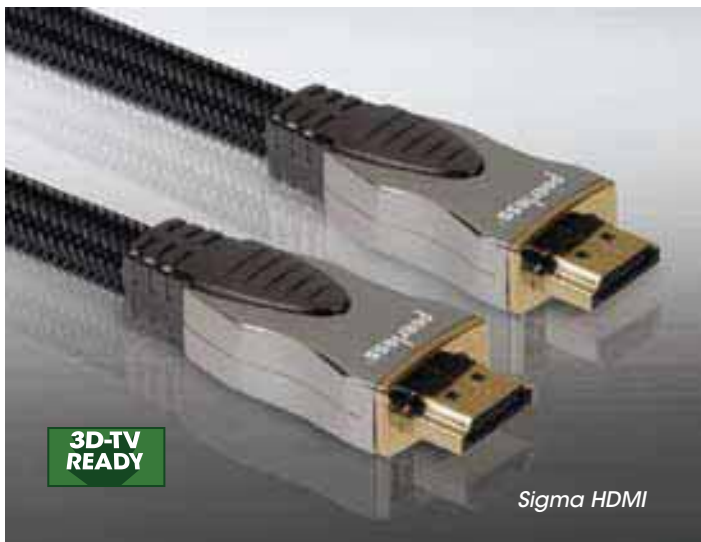

An AV system is only as good as its weakest link. The 'standard' cables that come supplied in the box cannot deliver the full sound and picture quality your AV equipment is capable of.

Peerless offers a range of cables for every budget. From OMEGA - the ultimate quality interconnect for the ultimate performance, through to ALPHA - your first upgrade cable, you can be assured that a Peerless cable delivers performance, quality and value regardless of the cable you choose.

OMEGA SERIES



The ULTIMATE choice

The Omega Series from Peerless has been created for one purpose: to deliver the ULTIMATE audio-visual experience from your AV equipment. Selecting the best combination of materials, design and manufacturing expertise, Omega sets the new standard for digital AV performance.

SIGMA SERIES



The best choice

When you wish to get the best performance from your AV system, the Sigma Series from Peerless is the right choice for you. Each and every detail that goes into a Sigma AV Interconnect has been specifically chosen to deliver the best audio or video performance possible. If you want the best, Sigma delivers!

DELTA SERIES



The better choice

DELTA AV Interconnects from Peerless are the choice for when you want to get more performance from your system. Precision engineered, all Delta interconnects use superior materials such as PCOFC conductors and RFI/EMI filters to deliver superior AV performance. The gunmetal-plated zinc headshells reflect the quality and performance of DELTA AV interconnects.

Peerless has a wide range of AV connectivity solutions and the above represents only some of the range highlights. Contact Peerless-AV UK for a dedicated AV connectivity brochure or visit www.peerless-av.co.uk for more information.



Available from:

peerless-AV

© 2010 Peerless Industries Inc. All rights reserved. E&OE
Selected photography is courtesy of Home Waves Inc.

All brands, product names and taglines are trademarks or registered trademarks of their respective owners.
BBG Distribution Ltd trading as Peerless-AV UK and Peerless-AV Europe